



## Aluminum Universal System

Design *X-line* wall-GLASS EXCLUSIVE



# Design X-line wall-GLASS EXCLUSIVE

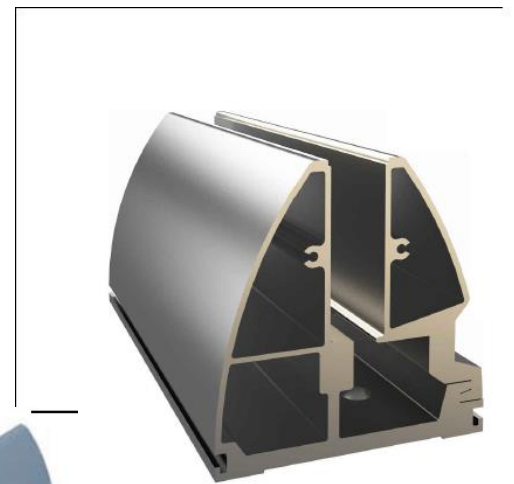
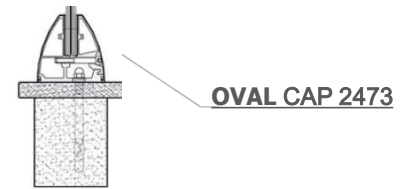
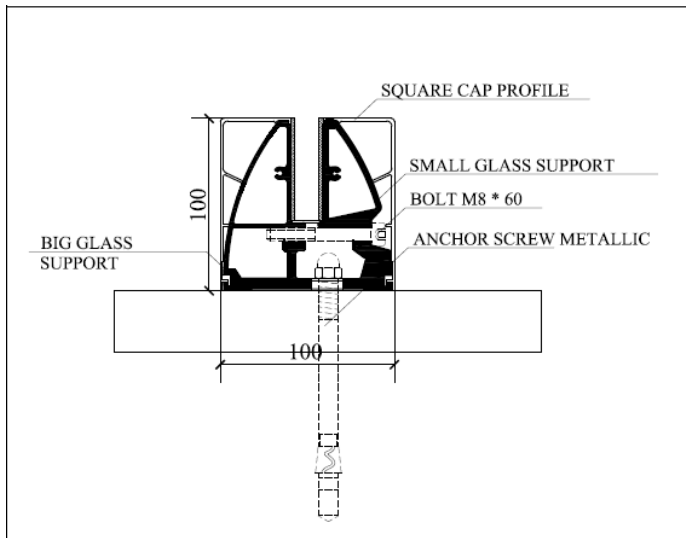
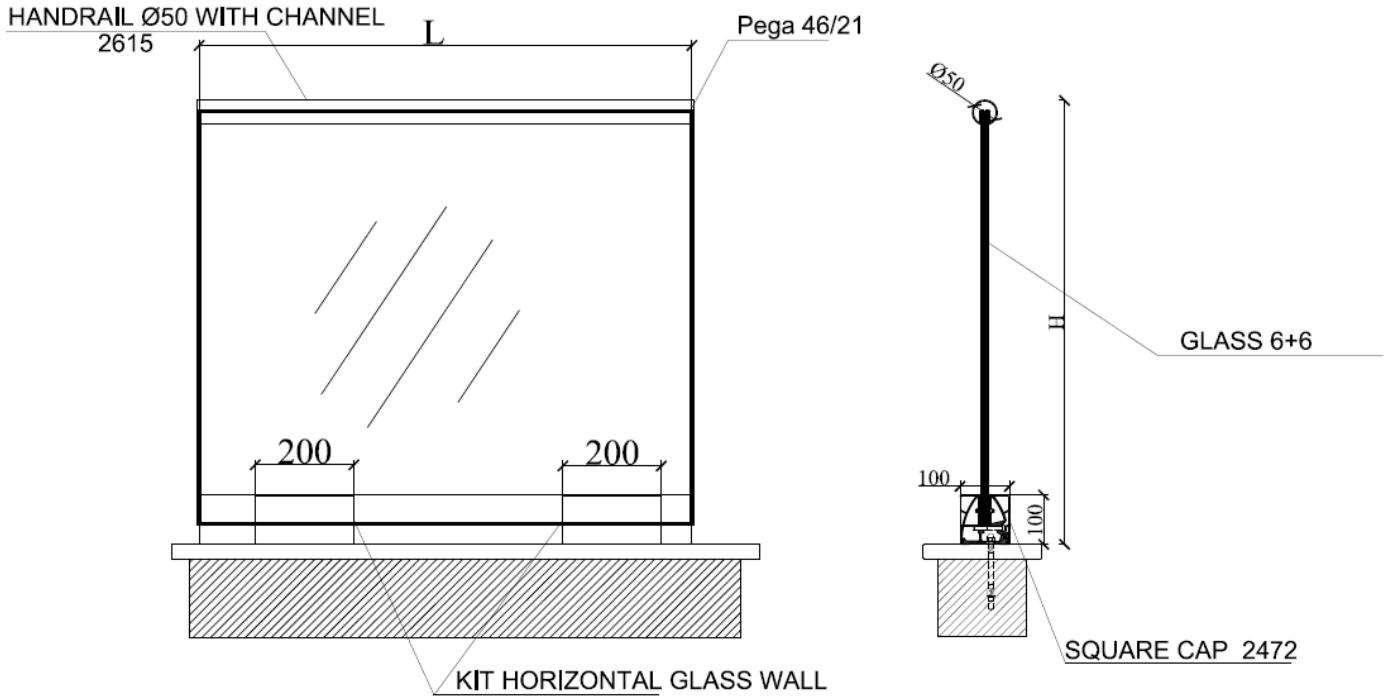

Square Endcap

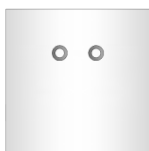

Oval Endcap

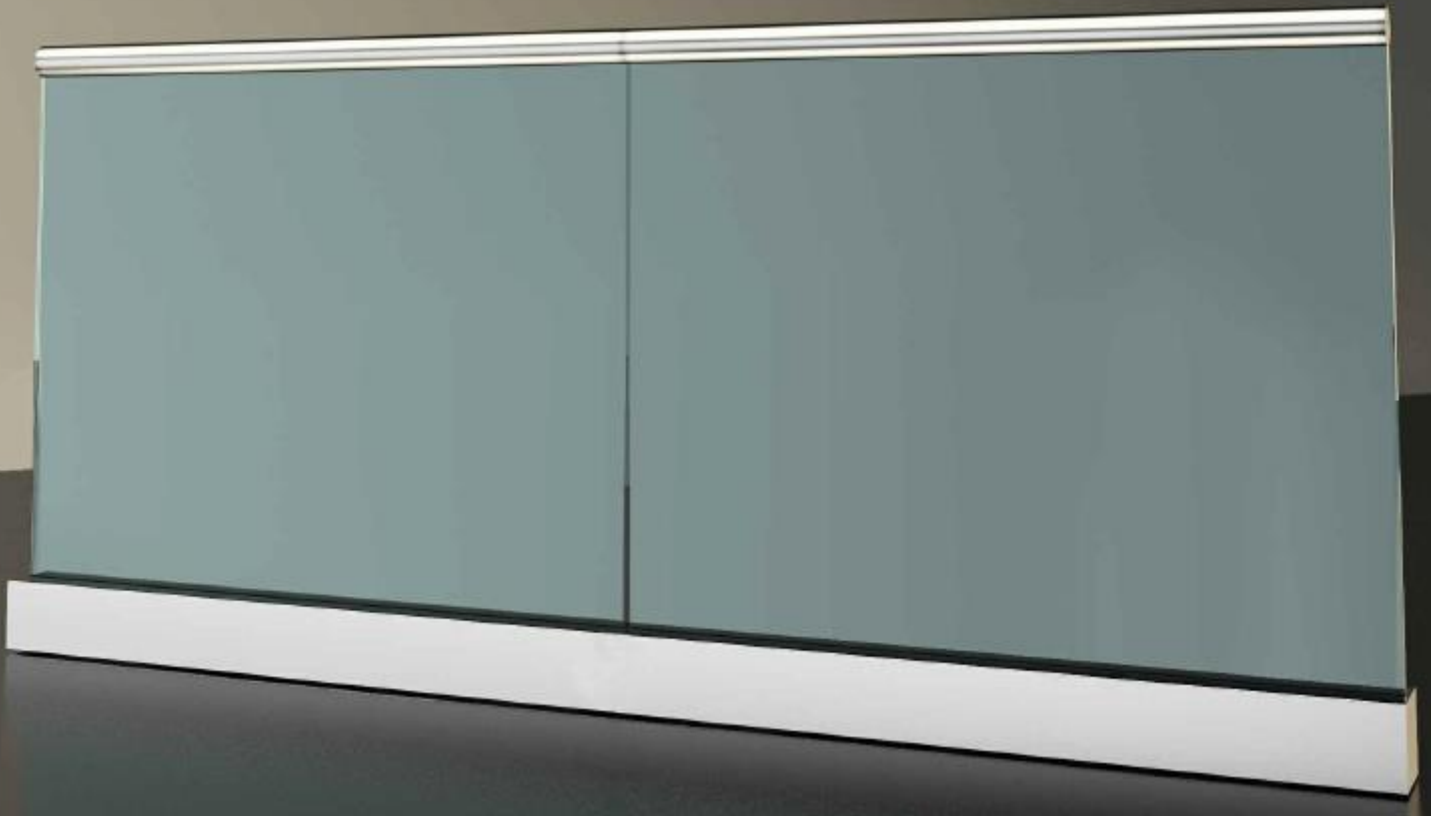

*Optimal base installation distance D*

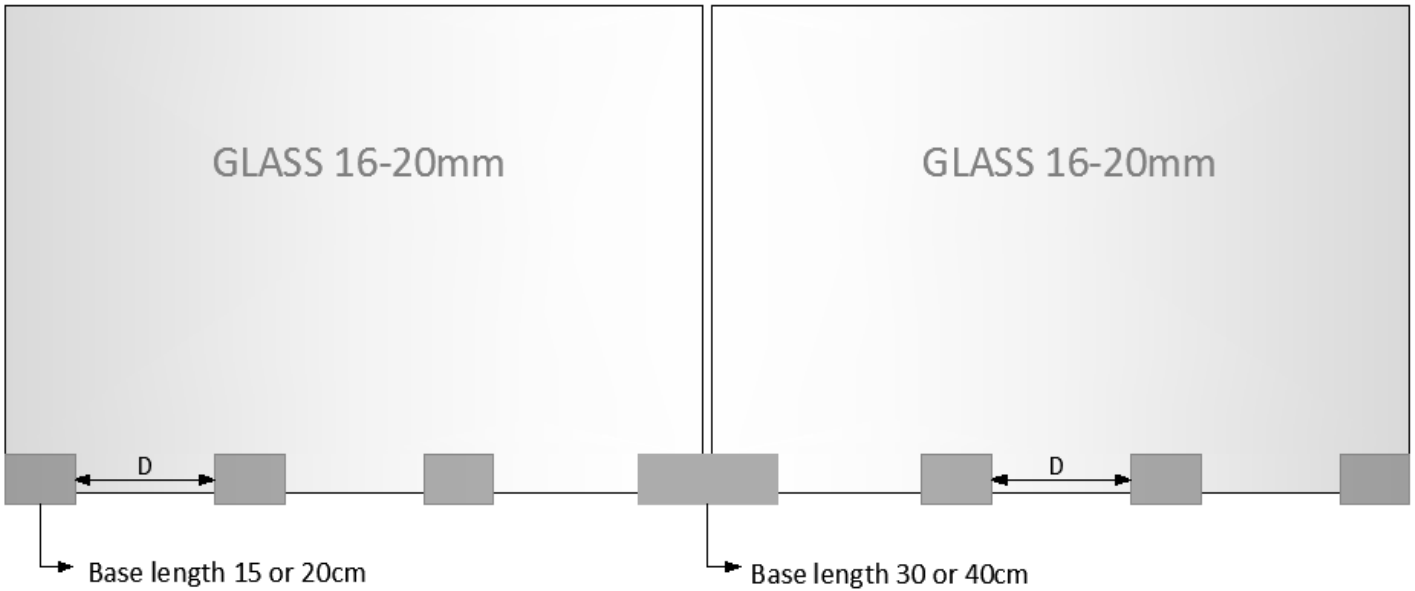

- ✗ Glass height 100cm D=25-30cm
- ✗ Glass height 90cm D=30-35cm
- ✗ Glass height 80cm D=35-40cm
- ✗ Glass height 70cm D=40-45cm
- ✗ Glass height 60cm D=45-50cm
- ✗ Glass height 50cm D=50-55cm
- ✗ Glass height 40cm D=55-60cm

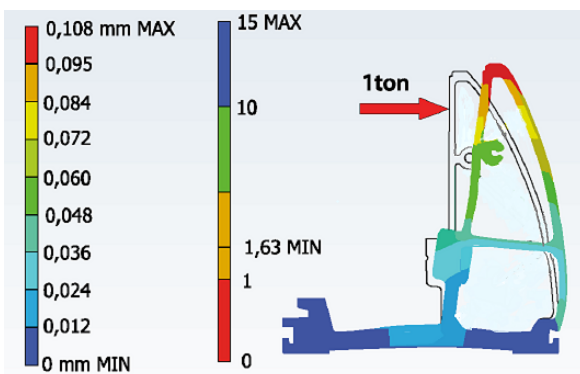

Fatigue of a 50cm base length with 1 ton(10.000Nt) perpendicular load power to the resting surface of the plate glass.

- **Prices**

- ✗ The above-mentioned prices are EX WORKS (Bulgaria).
- ✗ The prices are only valid for customer who possess a valid VAT number (VAT EXCLUDED)
- ✗ **MINIMUM** orders 5000.00 EUR
- ✗ The above-mentioned prices are subject to our General Terms and Conditions

- ✗ **Warranty**

Differing from the German Civil Code /article 438 our construction materials do carry a two year warranty which refers to manufacturing defects of the product and not to problems deriving from incorrect installation by third parties.



Belmelken 3, 1618 SOFIA , BULGARIA

Tel +30 2310 641 747

Tel +30 6974 740 020

Fax +30 2310 664 004

e-mail: [info@alfaergon.com](mailto:info@alfaergon.com)

[www.alfaergon.com](http://www.alfaergon.com)